

Instructions for Use

For Automatic Sliding Doors with Drive:

TORMAX 2201 Sliding Door Drive



Safety instructions in chapter 2 must be observed!

Contents

1	General Information	3
2	Safety	4
2.1	Responsibilities	4
2.2	Intended Use	4
2.3	Pre-conditions for the Operation of the System	4
2.4	Hazards and Risks	4
2.5	Checks	5
2.6	Decommissioning the System in the Event of a Fault	5
2.7	Disposal	5
3	Product Description	6
3.1	System Overview	6
3.2	System Function	7
3.3	Operating Modes	8
4	Operation	9
4.1	Commissioning	9
4.2	Operation with the TORMAX User Interface	9
4.3	Operation with an Operating Mode Switch	10
4.4	Operation on Power Failure	10
5	Procedure in the Event of a Fault	11
5.1	Fault indication	11
5.2	Restarting the Door System After a Fault (Software Reset)	11
6	Maintenance	12
6.1	Cleaning	12
6.2	Functional Checks	12
6.3	Maintenance and Testing	12
7	Appendix	13
7.1	Fault Table	13
7.2	Check-list for Functional Checks	14
	Declaration of Conformity	15

First edition: 9.04, Update: 4.12, 3.21

We reserve the right to make technical changes.

1 General Information

Target Groups



- Operator of the automatic sliding door. The operator is the person responsible for the operation and maintenance of the system.
- Persons instructed by the operator to carry out certain duties, for example the servicing and maintenance of the automatic sliding door.

Area of Application

Product name, door system: Automatic sliding door

Product name, door drive: **TORMAX 2201 Sliding Door Drive**

Identification plate: The identification plate with the serial number is attached to the header section.

		TORMAX Unterweg 14 CH-8180 Bulach-Zürich A Division of LANGERT Group AG			
Model:					
Un:					
Pmax.:		Imax:		Pedestrian Door Operator	
Pmin.:		Imin:		Manufactured: MM/YYYY	
Leaves:					Serial No.:

Explanation of the Symbols



The Warning message warns about possible risk of injury.

Text which is highlighted in grey **MUST** be observed to ensure that the system operates perfectly. Failure to observe these sections can cause damage to equipment.



Functions marked with this symbol are the factory setting. However, they can be reprogrammed by a skilled person.



Optional components which are not present in all systems.

Technical Data

Drive type	Electro-mechanical sliding door drive with DC motor
Control system	Control unit 2201 MCU8-CONU-85-B
Mains connection	1 x 230 VAC, 10 – 16 A / 1 x 115 VAC, 15 – 20 A, 50 – 60 Hz
Power consumption	max. 200 W
Motor	24 V DC, 4,9 A
Sensor supply	24 V DC, 1 A
Protective class, drive	IP 22
Ambient temperature	–20 °C to +50 °C
Noise emission level	< 70 db(A)

2 Safety

2.1 Responsibilities

For instructing the operator:	A skilled person from a TORMAX sales partner
For operating the system:	The operator or a person instructed by the operator
For maintenance and function control:	The operator or a person instructed by the operator
For annual testing and approval:	A skilled person authorised by the manufacturer

Skilled persons are persons who have adequate knowledge in the field of power-operated doors as a result of their specialist training and experience and who are so familiar with the relevant health and safety regulations, guide-lines and generally recognised codes of practice that they are able to assess the condition of power-operated doors with regard to the safety of their operation.

Maintenance of electrical parts must be carried out by a trained electrician.

2.2 Intended Use

The automatic sliding door is intended exclusively for use in dry premises in areas used as a pedestrian thoroughfare. The manufacturer will not accept any liability whatsoever for loss or damage caused by improper use, failure to comply with the maintenance specification (see section 6) or unauthorised modification of the system.

2.3 Pre-conditions for the Operation of the System

The door system was designed, installed and checked for functionality and safety by skilled persons prior to hand-over to the operator. The company responsible for the system's installation instructed the operator on the system's use and maintenance as well dangers associated with the system operation. The operator has confirmed this by his signature in the system test book T-879.

The provisions imposed by law, health and safety and occupational health regulations for the avoidance of accidents and the protection of the environment which are generally applicable in the country in which the system is operated supplement the Instructions for use.

- Read the Instructions for use carefully before commissioning the automatic sliding door.
- Only use the system when it is in perfect working order. The operating conditions, inspection and maintenance intervals stipulated by the manufacturer must be observed (section 6).
- Safety facilities (e.g. sensor technology, manual unlocking) must not be removed or disabled.
- Arrange to have any faults rectified immediately by a skilled person.

2.4 Hazards and Risks

Depending on the system design and equipment, there is a residual risk of crushing, entanglement and collision in the movement area of the door leaves – albeit with restricted force.

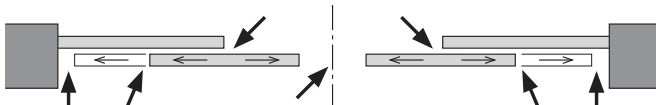

Hazards can arise:

- in the region of the secondary closing edges
- door guides in the floor
- in the split in the cladding for suspending the door
- if objects, for example sales stands, are erected in direct proximity to the operating range of the door leaves.
- due to deliberate damage by vandals, defective sensors or sensors which are no longer properly adjusted, sharp edges, incorrectly supported and defective casing or missing covers.

2.5 Checks

The regular checks and examinations set out in Chapter 6 must be carried out as instructed by the manufacturer. The manufacturer recommends that a maintenance contract be concluded in order to operate the system safely and to maintain its value for as long as possible.

2.6 Decommissioning the System in the Event of a Fault

If there is a fault the automatic door may only be taken out of service by a skilled person, the operator or a person who is instructed to do so by the operator. This must be done on all occasions on which the safety of persons could be compromised.

- Disconnect the system from the power supply.
- Select operating mode Manual Operation, if the system continues to operate using the internal emergency power supply (see section 4.2 for switching to manual operation).
- Open the door manually and leave open if it is installed in an escape route.

See section 7 for rectification of faults.

2.7 Disposal

This system must be properly dismantled at the end of its working life. Its disposal must comply with national regulations. We recommend that you contact a skilled person disposal company.



- Aggressive acids.
- Risk of injury if you dismantle the battery module.
- Dispose of batteries properly.



- Airborne parts.
- Risk of injury when dismantling the rubber cord suspension.
- Take care when releasing the tension on the rubber cord.



- Broken glass.
- Risk of injury when dismantling the door leaves.
- Take care when transporting the door leaves.

3 Product Description

3.1 System Overview

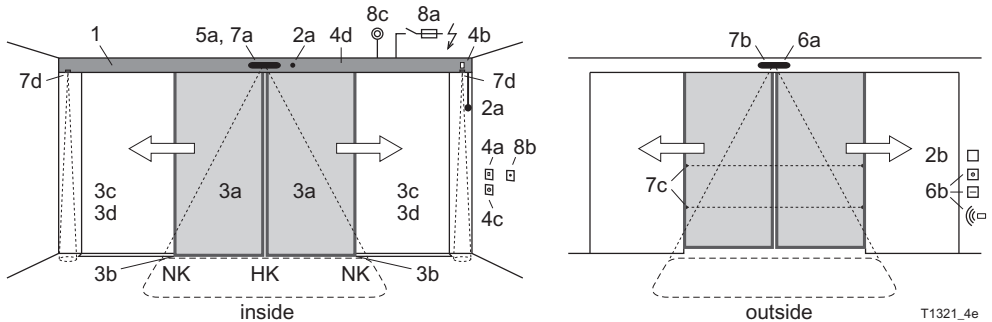

1 Drive	Cladding Motor unit MCU8 control system with monitoring system, power limitation and permanent diagnosis Guide system with noise-absorbent guide rail
2 Drive accessories ♦	<input type="checkbox"/> Lock with a) <input type="checkbox"/> internal manual activation <input type="checkbox"/> in the cladding <input type="checkbox"/> on the wall b) <input type="checkbox"/> external manual activation <input type="checkbox"/> Emergency power supply via the battery unit <input type="checkbox"/> Mechanical emergency opening
3 Door leaves	a) Moving leaves with main closing edge (HK) and secondary closing edge (NK) b) Moving leaves with floor guide c) <input type="checkbox"/> Side part ♦ d) <input type="checkbox"/> Protection leaves ♦ as protection for the secondary closing edge
4 Operating controls ♦	a) <input type="checkbox"/> User interface with 6 operating modes and fault indication b) <input type="checkbox"/> Operating mode switch with 3 positions. c) <input type="checkbox"/> Lock for the user interface d) <input type="checkbox"/> Remote control of operating modes
5 Internal activators	a) With automatic activation <input type="checkbox"/> Radar with/without direction recognition <input type="checkbox"/> IR motion detector b) With manual activation <input type="checkbox"/> Push button <input type="checkbox"/> Contact-free button
6 External activators	a) With automatic activation <input type="checkbox"/> Radar with/without direction recognition <input type="checkbox"/> IR motion detector b) With manual activation <input type="checkbox"/> Key switch <input type="checkbox"/> Card reader <input type="checkbox"/> Remote control
7 Safety sensors	a) <input type="checkbox"/> Presence sensor: main closing edge protection b) <input type="checkbox"/> Presence sensor, external: main closing edge protection c) <input type="checkbox"/> Safety beams d) <input type="checkbox"/> Presence sensors: secondary closing edge protection
8 Emergency systems	a) <input type="checkbox"/> Power switch/fuse b) <input type="checkbox"/> Emergency on/off switch c) <input type="checkbox"/> Fire alarm system
9 Output message ♦	<input type="checkbox"/> Bell/gong <input type="checkbox"/> Light/ventilation <input type="checkbox"/> Door locked <input type="checkbox"/> Door status

Depending on the system's equipment

3.2 System Function

It is the responsibility of the system operator to ensure that the automatic sliding door can be freely used at all times and particularly that access to the sliding door is not blocked.

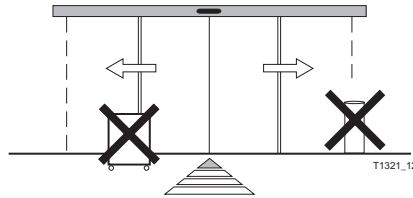

Automatic Door Operation with Sensors

When operating automatically (AUTOMATIC operating mode) the door is automatically opened from both sides by sensors when a person approaches.

A key switch ◆ or card reader ◆ normally allows access from outside when the door is in operating mode EXIT or OFF. The door unlocks, opens and closes again as soon as no further sensors are activated after a hold-open time which is set separately.

The sensors for the door opening and the maintained opening of the door are arranged and adjusted in such a way that the door opens promptly and remains open as long as a person is within the operating range of the door leaves. The door can close nevertheless but only after an attendance time of approx. > 1 minute.

The reduced closing speed which is set by the installer and is adjusted in line with the door weight, combined with a force of < 150 N prevents the impact of the moving leaves on a person from being too severe. The obstruction is also detected by the control system and the door automatically reverses.

Traffic Control

Movement through the door can be allowed in only one direction if desired (operating mode EXIT) or completely blocked (operating mode OFF).

In order to protect against environmental influences (e.g. wind / cold / heat) operating mode AUTORED can be used to operate the door with a narrower opening width of at least escape route width.

Automatic System Monitoring

The control system monitors the safety sensors by a cycle of active tests. The control system also conducts continuous internal system tests. If a safety-related component should fail, the system automatically switches into a safe condition. At the same time the fault number is displayed on the user interface. You can find further information on this subject in section 5 "Procedure in the Event of Faults".

Electro-mechanical Lock ◆

The system can be locked in the closed position by means of an electro-mechanical lock ◆ or held in the closed position by a holding magnet ◆ when in operating mode OFF and, if required, in other operating modes (e.g. EXIT).

The locking process is monitored. Thus any fault of the locking operation can be immediately displayed on the user interface. See section 5 "Procedure in the Event of Faults" for details.

In the event of a power failure the locks can also be directly activated by the optional manual facility.

Operation in the Event of a Power Failure

Depending on the equipment installed, the following functions are possible:

- Immediate emergency opening or closing by a mechanical energy store system.

- Continued operation of the system by means of a battery unit ♦ for a specific time with the doors opening before the battery switches off. The door remains locked in operating mode OFF.
- Unlocking and opening of the door from outside by means of a key switch and the battery unit ♦.

3.3 Operating Modes

By using the TORMAX user interface ♦ it is possible to operate the automatic door system in 6 operating modes and with status displays or to use a simple operating mode switch ♦ to operate the door in 3 operating modes.



Operating Mode OFF

The internal and external sensors are disregarded. The door is maintained in the closed position either by the motor or the holding magnet ♦ and/or locked by the electro-mechanical lock ♦. Access is only possible using the key switch ♦.



The door can still be used for 10 seconds after selecting operating mode OFF. The transition is signalled on the user interface by the flashing display of operating mode OFF.



Operating Mode AUTO

The operating mode AUTO is normally used during the day. The door opens automatically to its full opening width to both sides by means of the internal and external sensors.



Operating Mode AUTORED

Operating mode AUTORED is normally used for daytime operations. The door opens automatically with a reduced opening width to both sides by means of the internal and external sensors.



If required, the opening width can be altered by the installer.



Operating Mode EXIT

Operating mode EXIT is normally used for the period before the shop or office closes. The door will only open automatically when activated by the internal sensor.

When the door opens the external sensor is also monitored for safety reasons.

The opening width is determined by previously selecting operating mode AUTO or AUTORED. The door can be automatically blocked using the holding magnet ♦.



Operating Mode OPEN

The door opens and remains open. The opening width is determined by the prior selection of operating mode AUTO or AUTORED.

Operating Mode Manual Operation

The door leaves can be freely moved. This operating mode can be used for cleaning the door leaves and the floor guide or for temporarily shutting down the door. The system is reset after leaving this operating mode.

4 Operation

The automatic sliding door may only be operated by a skilled person, the operator or a person instructed by the operator.

4.1 Commissioning

Before switching on the mains power supply:

- Unlock the optional mechanical door lock e.g. floor lock.
- Check that the movement area of the door leaves is free from objects e.g. umbrella stands or vehicles.
- Check that the floor guide (particularly if it is continuous) is clean and not blocked by anything (e.g. gravel or snow).
- Switch on the mains power supply and select operating mode AUTO, for example.
- Wait until the door is closed.
 - The first movement after switching the power on for the first time is slow. The control system is checking the door leaf's travel distance and defining the end position.
 - The door is now ready for operation.

4.2 Operation with the TORMAX User Interface ♦

TORMAX User Interface

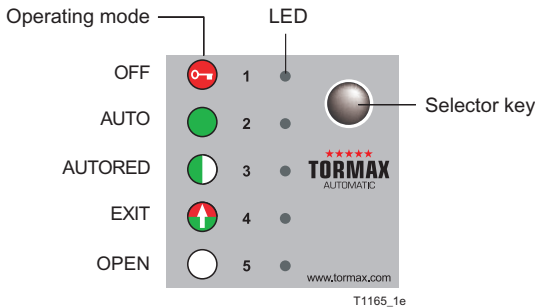

Lock ♦ for User Interface

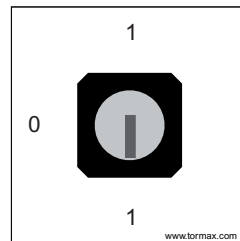

Selection of Operating Modes

- Release lock ♦ for user interface.
- Press selector key briefly. The corresponding operating mode symbol is illuminated.

Switching to manual operation

- Press the selector key and hold down for 5 seconds.
 - Manual operation is indicated by all five LEDs flashing.
- Press the selector key briefly to switch out of manual mode.

Fault indication

e.g. LED 4 flashes. See Section 5 for how to proceed in the event of faults and how to reset the system. See chapter 7 for the definition of the fault.

4.3 Operation with an Operating Mode Switch ◆

Selection of Operating Modes

The operating mode can be set directly.

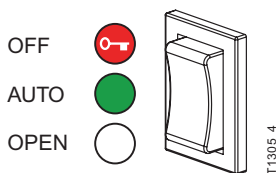

4.4 Operation on Power Failure

Manual Locking ◆

- Press the manual operation knob inwards.
- Push the door closed by hand until the latch engages.



Manual Unlocking ◆

- Pull the manual operation knob outwards.
- Push the door open by hand.

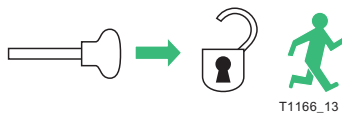

Opening a Door with a Battery Unit ◆ Using a Key Switch ◆

- Turn the key switch to the “on” position and hold in place for at least 5 seconds, then turn the key to the original position.

The key switch must not remain permanently in the “on” opposition.

- The battery is activated using the “wake up” function.
- The door is unlocked, opens, closes slowly and locks again.
- The battery switches off automatically again after 90 seconds.

5 Procedure in the Event of a Fault

Faults are evident through unusual behaviour by the door and/or are indicated by the flashing light-emitting diodes (LEDs). The display takes the form of either a single flashing LED or by "Manual operation" being indicated if the system was automatically shut down by the control unit or an emergency opening was triggered. In this case the fault number is indicated by the single LED that is not illuminated.

5.1 Fault indication

See the table in Section 7.1 for a summary of fault signals and possible means of rectification.

Example: Display of fault number 3

LED 3 flashes

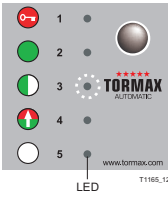

or →

All except LED 3 are flashing – The door system is in MANUAL OPERATION because of fault number 3

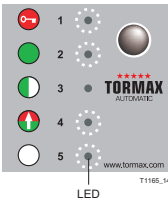

Example: Display of fault number 5

All except LED 5 are flashing – The door system is in MANUAL OPERATION because of fault number 5

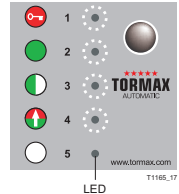

5.2 Restarting the Door System After a Fault (Software Reset)

Reset after a fault with the TORMAX user interface

Occasional faults can be rectified by re-starting the system.



- Press selector button 5 and hold down for 5 seconds – the software is reset.

Resetting after fault number 5



- Press selector key briefly
- Change operating mode
- Turn the key switch on and then off again quickly

The software is reset
→ manual operation is reset;
the door opens and closes slowly.

Reset of the Fault by Disconnecting the Power Supply

- If the system does not have a battery unit, disconnect from the power supply for about 10 seconds.

If this does not reset the fault or if it re-occurs after a short time, you must arrange for the fault to be rectified by a skilled person from your TORMAX dealer. In this case note the fault number and inform the dealer. See the last page or the service tag on the system for the dealer's address.

6 Maintenance

The system was tested and approved by an expert before initial commissioning. The manufacturer recommends that you conclude a service contract in order to maintain the value of your system for as long as possible as well as to ensure the system operates reliably and safely for a long time.

Only genuine TORMAX spare part should be used. The manufacturer accepts no liability if you fail to observe this requirement.

The following maintenance work must be carried out:

6.1 Cleaning



- Closing doors can crush – danger!
- Trapped limbs can lead to serious injury.
- The system must only be cleaned in operating mode OFF, OPEN or Manual Operation.

- Clean casing parts, the user interface and door leaves with a damp cloth and a commercial cleaner.
- Remove dirt from the floor guide and clean with a damp cloth.

6.2 Functional Checks

The operator must check the function and safety devices of the automatic sliding door at least every 3 months. This will ensure that faults or hazardous changes in the system are detected at an early stage. See section 7.2 “Check-list for Functional Checks” for items to be checked.

You should arrange for any defects detected during the routine checks to be rectified immediately by a TORMAX dealer (see the last page of this Manual for the address).



- Potential switching malfunction in the automatic sliding door.
- Potential hazards – injury caused by impact or crushing.
- Do not use any part of your body for functional checks. Use a suitable object (e.g. styro-foam or cardboard) instead.

6.3 Maintenance and Testing

Maintenance and testing should only be carried out by a trained skilled person following the manufacturer’s instructions.

Maintenance Interval

The maintenance interval depends on the frequency of use but the system must be maintained at least once per year.

Scope of the Maintenance Work

The content of the maintenance work is specified by the manufacturer in an inspection list.

System Test Book



The test findings are recorded after the test in the system test book. The operator must keep it in a safe place.

7 Appendix

7.1 Fault Table

LED	Group of faults	Behaviour	Cause	Trouble shooting
1	Lock	<ul style="list-style-type: none"> • Door does not lock. • Door does not unlock and stays closed. 	<ul style="list-style-type: none"> • Lock latch stuck or defective. 	<ul style="list-style-type: none"> • Move lock latch manually. Free manual disengagement by turning button ccw for about 90 °. • If no success, or fault occurs repeatedly call TORMAX service.
2	Interface RS232 to user interface	<ul style="list-style-type: none"> • Operating mode cannot be changed. • No display on the user interface. 	<ul style="list-style-type: none"> • Connection from the control unit to the user interface interrupted 	<ul style="list-style-type: none"> • Call TORMAX service.
3	Safety facility	<ul style="list-style-type: none"> • Door remains open or • Door stops at the obstacle and leaves can be moved freely. 	<ul style="list-style-type: none"> • Safety sensor has been active for more than 5 min, or safety test is negative. • Reversing has been triggered 5 times in a row. 	<ul style="list-style-type: none"> • Remove objects in the door passage. • If no success, or fault occurs repeatedly call TORMAX service.
4	Activators	<ul style="list-style-type: none"> • Door remains open. 	<ul style="list-style-type: none"> • Activator inside/outside or key switch has been active for more than 5 min. 	<ul style="list-style-type: none"> • Reset key switch. • If no success, or fault occurs repeatedly call TORMAX service.
5	System	<ul style="list-style-type: none"> • Door stops and leaves can be moved freely. 	<ul style="list-style-type: none"> • Internal system fault. 	<ul style="list-style-type: none"> • Change operating mode (= RESET). • Activate key switch briefly. • If no success, or fault occurs repeatedly call TORMAX service.
All	No fault	<ul style="list-style-type: none"> • Door stops and leaves can be moved freely. 	<ul style="list-style-type: none"> • Operating mode MANUAL 	<ul style="list-style-type: none"> • Change operating mode
No display		<ul style="list-style-type: none"> • No reaction of the door and leaves can be moved freely. 	<ul style="list-style-type: none"> • Mains supply interrupted. • Emergency power supply switched off. • Drive is overheated. 	<ul style="list-style-type: none"> • Switch on mains → main fuse • Wait for 15 min. till drive has cooled down. • If no success, call TORMAX service.

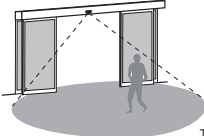
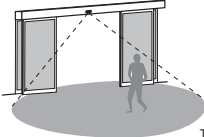
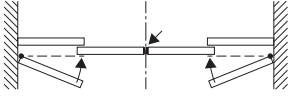
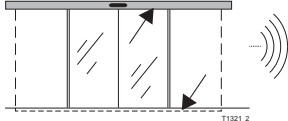
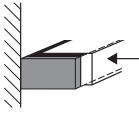
7.2 Check-list for Functional Checks

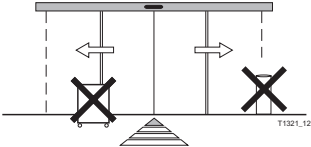
Item To Be Checked	Procedure	Resultat
 <p style="text-align: right; font-size: small;">T1321_7</p>	<ul style="list-style-type: none"> Walk through the door directly from the front and from different directions at normal speed, starting both from the inside and outside 	<p>The door opens at the right time and with sufficient speed so that passage through the door is not hindered.</p>
 <p style="text-align: right; font-size: small;">T1321_7</p>	<ul style="list-style-type: none"> Walk through the door directly from the front and from different directions at a slow speed like an infirm person, starting both from the inside and outside. 	<p>The door opens and remains open until you are completely through the door.</p>
Moving Leaves, Side Parts, Fixed Leaves		
	<ul style="list-style-type: none"> Check the glass door fillings, door edges and rubber profiles for damage. 	<p>The door fillings have no sharp edges and splintered glass.</p> <p>The side parts and the door seals are in place and undamaged.</p>
Guide System and Door Guides		
 <p style="text-align: right; font-size: small;">T1321_2</p>	<ul style="list-style-type: none"> Check the noises made while the door moves. 	<p>No unusual and noticeable movement noises can be heard in the drive, guide system or floor guides.</p>
Cladding		
	<ul style="list-style-type: none"> Check whether the cladding is correctly slotted into place and secured. 	<p>The cladding is firmly slotted into place.</p>
Operating Controls		
	<ul style="list-style-type: none"> Check the function and marking of operating controls. 	<p>The operating controls are functioning correctly; the markings are visible and legible.</p>
System Vicinity		
 <p style="text-align: right; font-size: small;">T1321_12</p>	<ul style="list-style-type: none"> Check access to the door and the movement area of the door leaves. 	<p>Access to the door is free from objects and items likely to cause the user to trip. There are no objects such as shelves, plant containers and umbrella stands within a radius of 50 cm of the movement area.</p>



EC Declaration of Conformity

The manufacturer (installation company) of the complete door system declares

Manufacturer's address: _____

that the product (door system)

Type designation: _____

Serial number: _____

is in conformity with the directive 2006/42/EC (Machinery Directive)

is in conformity with regulations of the guidelines:

- 2014/35/EU (low tension)
- 2014/30/EU (electro-magnetic-compatibility)

and the following harmonised standards have been adhered to:

- EN 16005

Base document:

- Declaration of incorporation by TORMAX I LANDERT Group AG
- Risk evaluation for automatic sliding doors I T-1178

Person responsible for documents

Name/address: _____

Place, date: _____

Signatory

(CE authorized person): _____

Signature: _____



the passion to drive doors

TORMAX Swing Door Drives

TORMAX Sliding Door Drives

TORMAX Folding Door Drives

TORMAX Revolving Door Drives

Producer

TORMAX
Unterweg 14
CH-8180 Bülach-Zürich

Phone +41 58 500 5000

Fax +41 58 500 5099

www.tormax.com

info@tormax.com

Installation company (installation, repairs,service)

TORMAX is a Division and a registered trademark of LANDERT Group AG