

Instructions for use

Drive for Automatic TORMAX Sliding Door

TORMAX 2203 Sliding Door Drive

TORMAX 2203.HB Sliding Door Drive



Safety instructions in chapter 2 must be observed!

Contents

1	General information	3
1.1	Target groups	3
1.2	Storage and forwarding of the manual	3
1.3	Area of application	3
1.4	Explanation of the symbols	4
1.5	Technical data	4
2	Safety	5
2.1	Responsibilities	5
2.2	Use for the purpose intended	5
2.3	Improper use	5
2.4	Pre-conditions for the operation of the system	6
2.5	Hazards and risks	6
2.6	Checks	7
2.7	Decommissioning the system in the event of a fault	7
2.8	Disposal	7
3	System overview	8
4	System functions	10
4.1	Automatic door operation with sensors	10
4.2	Traffic control	10
4.3	Automatic system monitoring	10
4.4	System with full-energy mode	10
4.5	System with low-energy mode	10
4.6	Electro-mechanical lock/holding brake	10
4.7	Operation in the event of a power failure	11
4.8	Operating modes	12
5	Operation	13
5.1	Commissioning	13
5.2	Operation with the TORMAX user interface	13
5.3	Setting customer parameters with the TORMAX user interface	14
5.4	Operation with an operating mode switch	16
5.5	Operation on power failure	16
6	Procedure in the event of a fault	17
7	Maintenance	18
7.1	Cleaning	18
7.2	Functional checks	18
7.3	Maintenance and testing	18
8	Appendix	19
8.1	Fault table	19
8.2	Check-list for functional checks	21
	Declaration of conformity	23

First edition: 3.22

We reserve the right to make technical changes.

1 General Information

1.1 Target Groups

- Operator of the automatic door. The operator is the person responsible for the operation and maintenance of the system.
- Persons instructed by the operator to carry out certain duties, for example the servicing and maintenance of the automatic sliding door.

1.2 Storage and Forwarding of the Manual

- Store the instructions for use in the vicinity of the automatic door system.
- If the manual has become illegible due to constant usage, reorder the instructions or download from: www.tormax.com
- When the door system is transferred or resold to a third party, pass the following documents to the new owner:
 - This instructions for use
 - Documentation concerning modification and repair work
 - Proof of the regular examinations → System test book T-879

1.3 Area of Application

Product name, door system: Automatic sliding door

Product name, door drive: **TORMAX 2203 Sliding Door Drive**

TORMAX 2203.HB Sliding Door Drive

The drive name is indicated in an abbreviated form in the Instructions.

The door drives are defined in more detail by a 4-figure number:

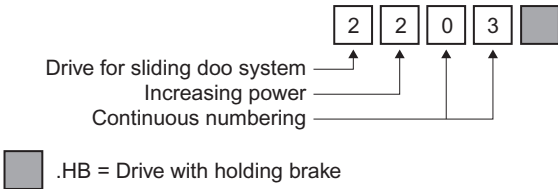

Door system identification plate (example):
located on the side panel of the drive.



Identification plate with the serial number:
located on the drive.

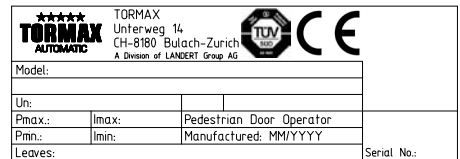

1.4 Explanation of the Symbols



Warning (signal word)

Source of hazard (designates a possibly hazardous situation)

Possible consequences of non-observance

- Measures for averting danger.

Text which is highlighted in grey MUST be observed to ensure that the system operates perfectly. Failure to observe these chapters can cause damage to equipment.

⊙ Functions marked with this symbol are the factory setting. However, they can be reprogrammed by a qualified person.

◆ Optional components which are not present in all systems.

1.5 Technical Data

Drive type	Electro-mechanical sliding door drive with an DC motor
Control system	Control unit MCU42
Mains connection	1 × 230 V 10 – 16 A 1 × 115 V 15 – 20 A
Power consumption	max. 230 W
Sensor supply	24 V DC (+0.5–1.5V) 15 A, in battery operation min. 16.5V
Protective class, drive	IP20
Fuse	8 AT
Ambient temperature	–20 °C to +50 °C, humidity non-condensing
Emission sound pressure level	Typically 55 dB (A) at 50 cm/s, depending on door and substructure
Electromagnetic compatibility (EMV)	IEC 61000-6-2, IEC 61000-6-3
Service life	Tested to 2 000 000 cycles

2 Safety



Warning

Important Safety Instructions

It is important to comply with these Instructions to ensure the safety of persons. These Instructions must be kept in a safe place.

2.1 Responsibilities

Installation of the system:	A qualified person from a TORMAX sales partner
For instructing the operator:	A qualified person from a TORMAX sales partner
For operating the system:	The operator or a person instructed by the operator
For maintenance and function control:	The operator or a person instructed by the operator
For annual testing and approval:	A qualified person authorised by the manufacturer

Qualified persons are persons who have adequate knowledge in the field of power-operated doors as a result of their specialist training and experience and who are so familiar with the relevant health and safety regulations, guide-lines and generally recognised codes of practice that they are able to assess the condition of power-operated doors with regard to the safety of their operation.

Maintenance of electrical parts must be carried out by a trained electrician.

2.2 Use for the Purpose Intended

The product including the associated components is designed for the automation of horizontally moving sliding doors for pedestrian access doors. The drive must only be installed in a dry environment inside buildings.

- Assembly, installation, repair and maintenance work and the commissioning of the drive must only be undertaken by qualified persons. This competent person is also responsible for the safety of users or third parties.
- The sliding door drive may only be operated by properly trained persons who must also follow the Instructions for Use.
- The door system may be used by persons with impaired physical, mental or sensory capabilities provided that they are either under the supervision of the person responsible for their safety that the latter has instructed them on the safe use of the system and its potential risks.
- Children must be supervised to ensure that they do not play close to the system and do not operate any available operating controls.

2.3 Improper Use

The manufacturer will not accept any liability whatsoever for loss or damage caused by improper use, failure to comply with the maintenance specification (see chapter 7) or unauthorised modification of the system.

- Any conversion of the system (e.g. other user groups) is not permitted without a new risk assessment (by a qualified person) and the measures derived from it.
- Structural alterations in the danger area around the door system are prohibited without a new risk assessment (by a qualified person) and the measures derived from it.
- Modifications to the door system (e.g. different, heavier door leaves, different operating equipment or sensor systems) may only be undertaken by a properly trained person who complies with the technical limit values.
- Safety facilities (e.g. sensor technology, manual unlocking) must not be removed or disabled.
- User maintenance and cleaning of the system must not be undertaken by children.

Other improper uses (examples)

- Automatic doors with leaves moving vertically.
- Automatic doors with leaves moving in an inclined plane.
- Door systems incorporating a wicket door must not be automated.
- The drive must not be used as a drive for a wicket door.
- Automatic doors and gates located in transport equipment (e.g. motor vehicles or lifts).
- Use in abrasive and corrosive environments or in areas subject to the danger of explosions.

2.4 Pre-conditions for the Operation of the System

The door system was designed, installed and checked for functionality and safety by specialists prior to hand-over to the operator. The company responsible for the system's installation instructed the operator on the system's use and maintenance as well dangers associated with the system operation. The operator has confirmed this by his signature in the system test book T-879.

The provisions imposed by law, health and safety and occupational health regulations for the avoidance of accidents and the protection of the environment which are generally applicable in the country in which the system is operated supplement the instructions for use.

- The persons responsible (see chapter 2.1) must have read and understood these Instructions before commissioning or using the door system.
- Only use the system when it is in perfect working order. The operating conditions, inspection and maintenance intervals stipulated by the manufacturer must be observed (chapter 7).
- Arrange to have any faults rectified immediately by a qualified person.

2.5 Hazards and Risks

Depending on the system design and equipment, there is a residual risk of crushing (1), entanglement (2) and collision (3) in the movement area of the door leaves – albeit with restricted force.

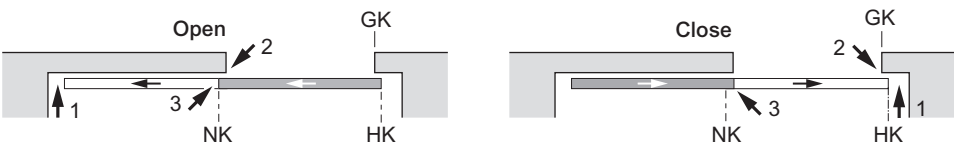

HK: Main closing edge

NK: Secondary closing edge

GK: Counter closing edge



Warning

Danger through moving parts:

- in the area of all closing edgess
- in the gap for suspending the door in the cladding
- when objects such as, for example, display shelves are erected in the direct proximity of the moving part of the door leaf.



Warning

Hazards can arise due to deliberate damage, incorrect installation, defective sensors or sensors which are longer properly adjusted, sharp edges, incorrectly mounted and defective casing or missing covers.

Danger for body and life, danger of injury

- Have system repaired by a qualified person.

2.6 Checks

Regular checks and inspections are to be carried out in accordance with chapter 7.

2.7 Decommissioning the System in the Event of a Fault

If there is a fault the automatic door may only be taken out of service by a qualified person, the operator or a person who is instructed to do so by the operator. This must be done on all occasions on which the safety of persons could be compromised.

- Switch off the mains power supply to the system. All the poles are disconnected using a 3-pole IEC-plug or another all-pole disconnection device (e.g. in the fuse box).
- If another power source (e.g. battery ♦) is available, it must be disconnected from the system by a qualified person.

See chapter 6 and 8 for rectification of faults.

2.8 Disposal

This system must be properly dismantled at the end of its service life. Its disposal must comply with national regulations. We recommend that you contact a specialist disposal company.



Warning

Aggressive acids

Risk of injury if you dismantle the battery module.

- Dispose of batteries properly.



Warning

Broken glass

Risk of injury when dismantling the door leaves.

- Take care when transporting the door leaves.



Warning

Broken glass

Risk of injury when dismantling the door leaves.

- Take care when transporting the door leaves.

3 System Overview

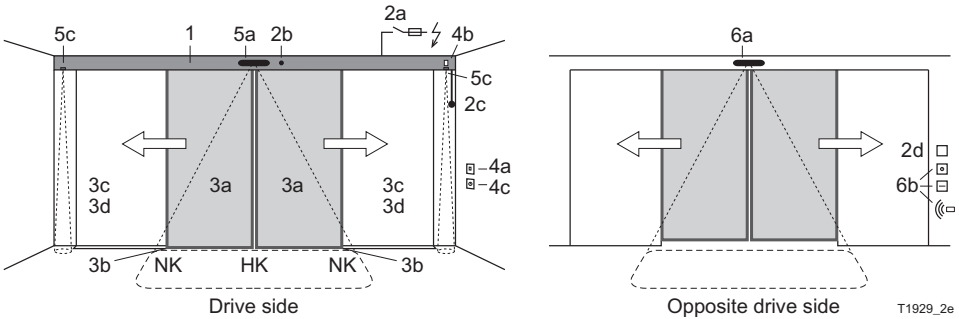

1 Drive	Cladding Motor unit MCU42 control system with monitoring system, power limitation and permanent diagnosis Guide system with noise-absorbent guide rail		
2 Drive accessories	a) <input type="checkbox"/> Mains switch * b) <input type="checkbox"/> Lock with: c) <input type="checkbox"/> internal manual activation <input type="checkbox"/> in the cladding <input type="checkbox"/> on the wall d) <input type="checkbox"/> external manual activation <input type="checkbox"/> Emergency power supply via the battery unit <input type="checkbox"/> Mechanical emergency opening		
3 Door leaves	a) Moving leaves with main closing edge (HK) and secondary closing edge (NK) b) Floor guide for moving leaves * c) <input type="checkbox"/> Side part * d) <input type="checkbox"/> Protection leaves as protection for the secondary closing edge *		
4 Operating controls	a) <input type="checkbox"/> User interface USIN-7 with 6 operating modes and fault display b) <input type="checkbox"/> Operating mode switch with 3 positions. c) <input type="checkbox"/> Lock for the user interface <input type="checkbox"/> Remote control of operating modes		
5 Activators drive side	a) with automatic activation <input type="checkbox"/> Combined sensor (activator/safety HK) <input type="checkbox"/> Radar with/without direction recognition * <input type="checkbox"/> IR motion detector * c) <input type="checkbox"/> Presence sensor *: Securing the secondary closing edge (NK) <table border="0" style="width: 100%;"> <tr> <td style="width: 50%; vertical-align: top;"> b) with manual activation <input type="checkbox"/> Push button * <input type="checkbox"/> Contact-free button * </td> <td style="width: 50%;"></td> </tr> </table>	b) with manual activation <input type="checkbox"/> Push button * <input type="checkbox"/> Contact-free button *	
b) with manual activation <input type="checkbox"/> Push button * <input type="checkbox"/> Contact-free button *			
6 Activators opposite drive side	a) with automatic activation <input type="checkbox"/> Combined sensor (activator/safety) <input type="checkbox"/> Radar with/without direction recognition * <input type="checkbox"/> IR motion detector * <table border="0" style="width: 100%;"> <tr> <td style="width: 50%; vertical-align: top;"> b) with manual activation <input type="checkbox"/> Key switch <input type="checkbox"/> Card reader * <input type="checkbox"/> Remote control * </td> <td style="width: 50%;"></td> </tr> </table>	b) with manual activation <input type="checkbox"/> Key switch <input type="checkbox"/> Card reader * <input type="checkbox"/> Remote control *	
b) with manual activation <input type="checkbox"/> Key switch <input type="checkbox"/> Card reader * <input type="checkbox"/> Remote control *			
7 Output message	<input type="checkbox"/> Bell/gong * <input type="checkbox"/> Light/ventilation * <input type="checkbox"/> Door status message 1 <input type="checkbox"/> Door status message 2		
8 Low-energy	<input type="checkbox"/> Yes <input type="checkbox"/> No		

Depending on the system's equipment

* Not offered by the manufacturer.

The company installing the system must select and install suitable components in accordance with the product standard EN16005.

Block diagram

All work on the mains power supply cable and the system's cabling must only be undertaken by an authorised and properly trained person who must refer to all necessary documents.

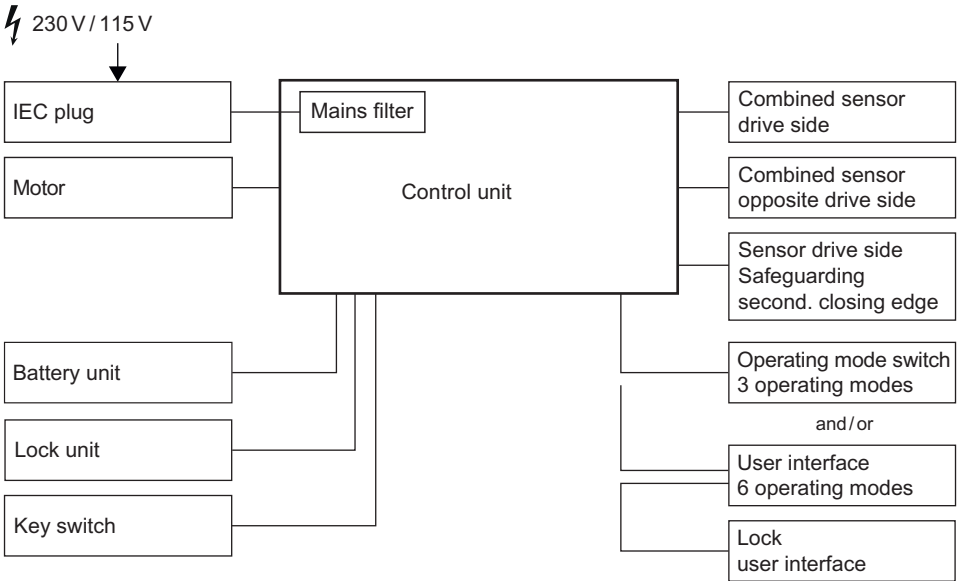

T1321_21e

4 System Functions

It is the responsibility of the system operator to ensure that the automatic sliding door can be freely used at all times and particularly that access to the sliding door is not blocked.

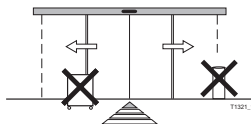

4.1 Automatic Door Operation with Sensors

When operating automatically (AUTOMATIC operating mode) the door is automatically opened from both sides by sensors when a person approaches.

A key switch ◆ or card reader ◆ normally allows access from outside when the door is in operating mode EXIT or OFF. The door unlocks, opens and closes again as soon as no further sensors are activated after a hold-open time which is set separately. The sensors for the door opening and the maintained opening of the door are arranged and adjusted in such a way that the door opens promptly and remains open as long as a person is within the operating range of the door leaves. The door can close nevertheless but only after an attendance time of minimum 30 s.

4.2 Traffic Control

Movement through the door can be allowed in only one direction if desired (operating mode EXIT) or completely blocked (operating mode OFF). In order to protect against environmental influences (wind/cold/heat) the door can be operated in operating mode AUTOMATIC 2 with a smaller opening width, which at least corresponds to the required passage width.

4.3 Automatic System Monitoring

The control system monitors the safety sensors by a cycle of active tests. The control system also conducts continuous internal system tests. If a safety-related component should fail, the system automatically switches into a safe condition. At the same time the fault number is displayed on the user interface. You can find further information on this subject in chapter 6 "Procedure in the Event of Faults".

4.4 System with Full-energy Mode

The safety sensors prevent a person from being bumped into in the travel area of the door leaf. If a safety sensor fails, the system is switched to safety operation. It can only be moved manually.

4.5 System with Low-energy Mode

The reduced closing speed set by the installer, which is adapted to the door weight, combined with a force of < 150 N, prevents an excessive impact by the moving leaf on a person. The obstacle is additionally detected by the control and an automatic reversal of the door is initiated.

4.6 Electro-mechanical Lock/Holding brake ◆

The system can be locked in the closed position by means of an electro-mechanical lock ◆ or held in the closed position by a holding brake ◆ when in operating mode OFF and, if required, in other operating modes (e.g. EXIT). The locking process is monitored. Thus any fault of the locking operation can be immediately displayed on the user interface. See chapter 6 "Procedure in the Event of Faults" for details. In the event of a power failure the lock can also be directly activated by the optional manual facility.

4.7 Operation in the Event of a Power Failure

Depending on the equipment installed, the following functions are possible:

With 6V battery module ♦

- In operating mode AUTO: The door opens immediately and remains open.
- In operating mode OFF: The door remains closed if it was locked mechanically at the moment of power failure. Otherwise the door opens and remains open.
- When power is restored the door closes again and functions according to the set operating mode.

With battery unit ♦

- Continued operation of the system by means of a battery unit ♦ for a specific time with the doors opening before the battery switches off. The door remains locked in operating mode OFF.
- Unlocking and opening of the door from outside by means of a key switch and the battery unit ♦.
- When power is restored the door closes again and functions according to the set operating mode.

Without 6V battery module ♦ / battery unit ♦

- In operating mode AUTO or OPEN: The door stands still and is then freely movable.
- In operating mode OFF: The door remains locked if a lock is installed. Otherwise the door leaves are freely movable.
- When power is restored the door closes again and functions according to the set operating mode.

4.8 Operating Modes

By using the TORMAX user interface ♦ it is possible to operate the automatic door system in 6 operating modes and with status displays or to use a simple operating mode switch ♦ to operate the door in 3 operating modes.

Operating mode OFF

The internal and external sensors are disregarded. The door is maintained in the closed position either by the motor or the holding magnet ♦ and/or locked by the electro-mechanical lock ♦. Access is only possible using the key switch ♦.

The door can still be used for 5 seconds after selecting operating mode OFF. The door then locks at the end of this period as soon as it is closed. The transition is signalled on the user interface by the flashing display of operating mode OFF.

Operating mode AUTOMATIC 1

The operating mode AUTOMATIC 1 is normally used during the day. The door opens automatically (normally to its full opening width) to both sides by means of the internal and external sensors.

Push and Go

If the door is pushed manually in the opening direction, it reacts as if to an opening command: It opens automatically, waits for the hold-open time and then closes again.

Operating mode AUTOMATIC 2

Operating mode AUTOMATIC 2 is normally used during the day. The door opens automatically (normally with a reduced opening width) to both sides by means of the internal and external sensors.

⊙ If required, the hold open time can be set by the installer for a different period to the one used in AUTOMATIC 1.

Operating mode EXIT

Operating mode EXIT is normally used for the period before the shop or office closes. The door will only open automatically when activated by the internal sensor.

When the door opens the external sensor also monitors for safety reasons.

The opening width is determined by previously selecting operating mode AUTOMATIC 1 or AUTOMATIC 2. The door can be automatically blocked using the holding magnet ♦.

Operating mode OPEN

The door opens and remains open. The opening width is determined by previously selecting operating mode AUTOMATIC 1 or AUTOMATIC 2.

P Operating mode manual operation

The door leaves can be freely moved. This operating mode can be used for temporarily shutting down the door. The system is reset after leaving this operating mode.

5 Operation

The automatic sliding door may only be operated by a qualified person, the operator or a person instructed by the operator.

5.1 Commissioning

Before switching on the mains power supply:

- Unlock the mechanical door lock (optional) e.g. floor lock.
- Check that the movement area of the door leaves is free from objects e.g. umbrella stands or vehicles.
- Check that the floor guide (particularly if it is continuous) is clean and not blocked by anything (e.g. gravel or snow).
- Switch on the mains power supply and select operating mode AUTOMATIC 1, for example.
 - The first movement after switching the power on for the first time is slow and H61/H62 is displayed. The control system is checking the door leaf's travel distance and defining the end position.
 - The door is now ready for operation.

5.2 Operation with the TORMAX User Interface

TORMAX User Interface

Operating mode:

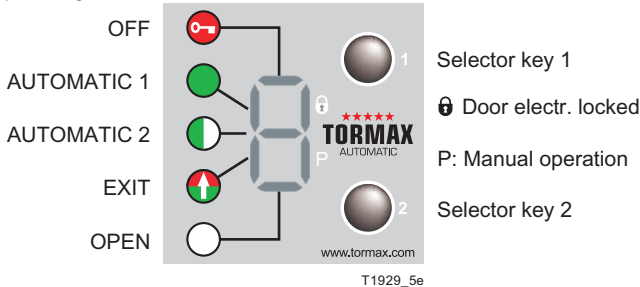

Lock ♦ for User Interface

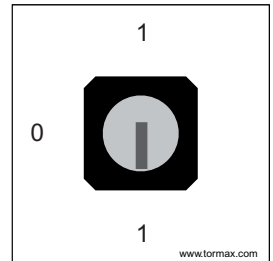

Unlocking of operating unit

The operating unit can be protected against unauthorised access by way of the lock ♦ or the code lock.

- Unlock lock = position 0

or

- Enter code ... / ... / ... using operating unit. The code can be determined by a qualified person. For changing the code, see chapter 5.3.

Example with code 3/3/3. Press upper selection button 3 times, then press the lower selection button 3 times and the upper selection button within 15 s . In case of entering wrong code: Wait at least 5 s . After successfully entering the code, the operating unit will be released within 60 s. The type of operation can be adjusted. Access will be automatically blocked again for 60 s after the button has been pressed for the last time.

Selection of operating modes

- Press selector keys 1 or 2 briefly. The corresponding operating mode symbol is illuminated.

Fault display

E.g. H31 or E11 → See chapter 8 for the meaning of the display.

- Reset by pressing the selector key 2 briefly.

Resetting the system

- Press the selector key 2 for at least 5 seconds.

The software is restarted. The control system then conducts a calibration run, checks the travel distance and looks for the end position again. Displayed as H61 and H62.

5.3 Setting Customer Parameters with the TORMAX User Interface

The company undertaking the installation reserves the right to restrict access to all or some of the customer parameter settings. If the user interface is in an area accessible to the public it must be protected against third party access by a “code lock” or a “lock for the user interface”.

Access level “U” for customer parameters

Indication of operating mode

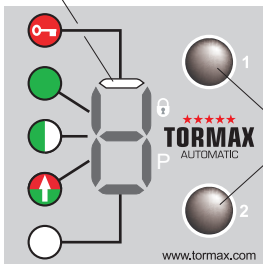

T1661_9e

Press keys 1 and 2 simultaneously until «U» appears

U appears, ready for programming

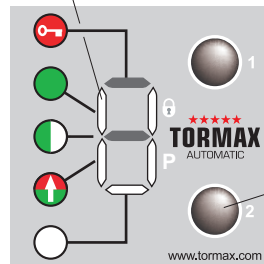

T1661_10e

Confirm with key 2

Enter the three digit code for parameters

Zero appears as first digit of code

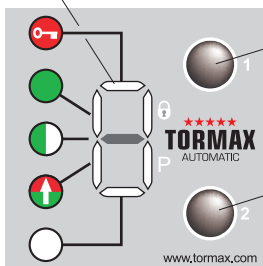

T1661_11e

Enter first code digit with key 1

Confirm with key 2

- Similarly, select and confirm the second and the third characters of the code.
- If “C” appears, access is blocked. Parameters cannot be re-set in this case.

Code	Parameter
------	-----------

Parameters for displays

0 1 3	Drive type (TORMAX 2203)
0 4 2	Firmware version
0 4 3	Number of cycles
0 4 4	Number of operating hours

Parameters for settings

1 0 ...	Hold open time for activator in AUTOMATIC 1
1 1 ...	Hold open time for activator in AUTOMATIC 2
1 2 ...	Hold-open time for key switch

3rd code digit:	0	1 *	2	3	4	5	6	7	8	9	A	b	C	d	E
sec.:	0,3	1	2	3	5	7,5	10	12.5	15	17,5	20	25	30	45	60

1 4 ...	Bell active time
---------	------------------

3rd code digit:	0	1	2 *	3	4	5	6	7	8	9
sec.:	0	0,5	1	2	3	4	5	6	8	10

1 5 ...	Hold-open time for Push and Go/ activator inside
---------	---

3rd code digit:	0	1 *	2	3	4	5	6	7	8	9	A	b	C	d	E
sec.:	0,3	1	2	3	4	5	6	8	10	12,5	15	17,5	20	40	60

2 0 ...	Opening speed
---------	---------------

2 1 ...	Closing speed
---------	---------------

3rd code digit:	0	1	2	3	4	5	6	7 *	8	9
cm/s:	10	15	20	25	30	40	50	60	70	80

4 0 ...	Partial opening width
---------	-----------------------

3rd code digit:	0	1	2	3	4	5	6	7	8	9	A *	b	C	d	E
%	2	3	5	10	20	30	40	50	60	65	70	75	80	90	100

4 1 ...	Opening width key switch
---------	--------------------------

3rd code digit:	0	1	2	3	4	5	6	7	8	9	A *	b	C	d	E
%	2	3	5	10	20	30	40	50	60	65	70	75	80	90	100

8 0 ...	Bell trigger
---------	--------------

3rd code digit:	0	1	2	3
	Activator outside	Activator inside	Key switch	Safety close

9 1 ...	Code lock for user interface (USIN)
---------	-------------------------------------

3rd code digit:	0 *	1	2	3	4
Code USIN	Switched off	111	222	333	123

Command

0 4 0	Software reset
-------	----------------

* = Default value

5.4 Operation with an Operating Mode Switch ◆

Selection of operating modes

The operating mode can be set directly.

(Reset the system after disconnecting the power supply for at least 5 seconds.)

OFF



AUTOMATIC 1



OPEN

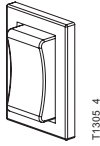

5.5 Operation on Power Failure

Manual locking ◆

- Press the pull handle inwards.
- Push the door closed by hand until the latch engages.
- Switch the operating mode switch to operating mode OFF. If a TORMAX user interface is used, operating mode OFF is automatically set when power is reconnected as the lock is engaged.

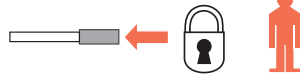

T1321_10

Manual unlocking ◆

- Pull the pull handle outwards.
- Push the door open by hand.
- Set the operating mode switch to the operating mode you want when power is restored.



T1321_8

Opening a door with a battery unit ◆ using a key switch ◆

- Turn the key switch to the “on” position and hold in place for at least 3 seconds, then turn the key to the original position.
→ The battery is activated using the “wake up” function.
- Turn the key briefly to the “on” position once more. If required, the operating mode can be changed on the user interface during the wake-up.

The key switch must not remain permanently in the “on” opposition.

- The door is unlocked and opened.
- The battery switches off again.

6 Procedure in the Event of a Fault

Faults are evident from abnormal door behaviour and/or as an error message on the user interface. Error messages on the user interface take the form of a flashing “E” or “H” followed by two figures.

H = notification > the system can continue to be used.

E = fault > the system is stationary.

Some faults or notifications can be rectified by restarting the door drive with a software reset and/or briefly disconnecting the system from the power supply.

Fault display and reset using the TORMAX user interface

See the table in chapter 8.1 for an overview of the fault displays.

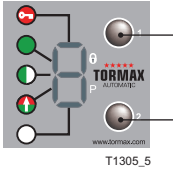

Browse through the fault display using selector key 1 (to display several faults).

1. Reset the error message, press selector key 2 briefly.
2. Software reset: press the key for 5 seconds.

Reset of the fault with the operating mode switch

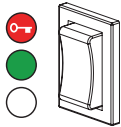

Software reset in the event of a fault: change the operating mode.

Reset of the fault by disconnecting the power supply

If the system does not have a battery unit, disconnect from the power supply for about 10 seconds.

If this does not reset the fault or if it re-occurs after a short time, you must arrange for the fault to be rectified by a qualified person from your TORMAX dealer. In this case note the fault number and inform the dealer. See the last page or the service tag on the system for the dealer's address.

7 Maintenance

The system was tested and approved by an expert before initial commissioning. TORMAX recommends that you conclude a service contract in order to maintain the value of your system for as long as possible as well as to ensure the system operates reliably and safely for a long time.

Only genuine TORMAX spare part should be used. The manufacturer accepts no liability if you fail to observe this requirement. Original spare parts and original accessories guarantee the safety of use in accordance with norm EN 16005.



Warning

Possible risk of injury!

Entrapment of limbs can lead to serious injury.

- The drive must be disconnected from all power sources, including batteries during cleaning and replacement of parts (see chapter 2.7).

7.1 Cleaning

- Clean casing parts, the user interface and door leaves with a damp cloth and a commercial cleaner.

7.2 Functional Checks

- Check the door system's function and safety devices **at least every 3 months**.

This will ensure that faults or hazardous changes in the system are detected at an early stage. See chapter 8.2 "Check-list for Functional Checks" for items to be checked.

- You should arrange for any defects detected during the routine checks to be rectified immediately by a TORMAX dealer (see the last page of this Manual for the address).



Warning

Potential switching malfunction in the automatic sliding door.

Potential hazards – injury caused by impact or crushing.

- Secure the area around the door while checking the door's functions.

7.3 Maintenance and Testing

Maintenance and testing should only be carried out by a trained specialist following the manufacturer's instructions.

Maintenance Interval

The maintenance interval depends on the frequency of use but the system must be maintained **at least once per year**.

Scope of the maintenance work

The content of the maintenance work is specified by the manufacturer in an inspection list.

System test book

The test findings are recorded after the test in the system test book. The operator must keep it in a safe place.

8 Appendix



8.1 Hint and Fault Table

System behaviour	No.	Cause	Remedy/ rectification
The door reverses when opening.	H31	Electronic obstacle recognition on opening by a person, wind pressure, ventilation or dirt in the floor guide.	Remove the obstruction. Clean the floor guide.
Door reverses when closing.	H32	Electronic obstacle recognition on closing by a person, wind pressure, ventilation or dirt in the floor guide.	Remove the obstruction. Clean the floor guide.
The door stops repeatedly when opening.	H33	Electronic obstacle recognition on opening in the same position by stationary obstacle.	Remove the obstruction. Clean the floor guide.
The door stops repeatedly when closing.	H34	Electronic obstacle recognition on closing in the same position by stationary obstacle.	Remove the obstruction. Clean the floor guide.
Door remains open.	H41	Step function active.	Automatic reset after an impulse.
Door remains open.	H44	Manual reset button > 1 min. active.	Have the sensor repaired by a qualified person. Reset key switch.
Door stays still.	H45	Door leaf deflected.	Engage the door leaf. Otherwise have the system repaired by a qualified person.
Search run notified.	H61 H62	Search run of the door after a reset or after power recovery.	Allow the search run to travel its full course.
Door operates at a reduced speed.	H71	Battery operation	Wait for power recovery, switch on mains supply.
Door remains open or in normal operation.	H72	Battery charge < 15 %	Wait until the battery is sufficiently charged.
Door remains closed.	–	Operating mode such as OFF, EXIT or P.	E.g. select operating mode AUTOMATIC 1.
Door remains open.	–	Operating mode such as OPEN or P.	E.g. select operating mode AUTOMATIC 1.
Door stays still.	E0 ...	Safety shutdown of control.	Perform software reset. Otherwise have the system repaired by a qualified person.
The door does not lock in OFF.	E11	Lock is jammed or defective.	Push the door leaves for a few seconds against the closed position in operating mode OFF when the door is closed. Have the system repaired by an expert.
The door does not open after changing from OFF to AUTOMATIC. The lock makes switching noises from time to time.	E11	Lock is jammed or defective.	Push the door leaves for a few seconds against the closed position in operating mode AUTOMATIC 1. Have the system repaired by an expert.

System behaviour	No.	Cause	Remedy/ rectification
The door does not open in OFF when the key switch is used. The lock makes switching noises.	E11	Lock is jammed or defective..	Switch on with the key switch and then push the door leaves briefly against the closed position. Have the system repaired by a qualified person
Dependent on configuration.	E2 ...	Error in bus system	Have the system repaired by a qualified person.
The door closes slowly/ the door remains open.	E31	The safety facility in the closing direction is permanently active (>1 min.) or defective.	Remove objects from the sensor area. Otherwise have the system repaired by a qualified person
The door closes slowly/ the door remains open.	E32	The safety facility in the closing direction is permanently active (>1 min.) or defective.	Remove objects from the sensor area. Otherwise have the system repaired by a qualified person
The door opens slowly/ the door remains open.	E33	The safety facility in the opening direction is permanently active (> 1 minute) or defective.	Remove objects from the sensor area. Otherwise have the system repaired by a qualified person
The door remains open/ the door remains open.	E34	The safety facility in the opening direction is permanently active (> 1 minute) or defective.	Remove objects from the sensor area. Otherwise have the system repaired by a qualified person
The door remains open.	E41 E42	Activator inside > 1 min. active. Activator outside > 1 min. active.	Get sensor adjusted by an expert. Reset the key switch.
Door remains open.	E43	Key switch > 1 min. active.	Reset key switch.
Door remains open.	E44	Emergency opening except in operating mode OFF.	Have the system repaired by a qualified person.
Door remains open.	E45	Emergency opening > 1 min. active.	Have the system repaired by a qualified person.
Door remains open.	E46	Emergency closing > 1 min. active.	Have the system repaired by a qualified person.
Door remains open.	E47	Emergency opening in case of fire > 1 min. active.	Have the system repaired by a qualified person.
Door remains closed.	E48	Emergency closure in case of fire > 1 min. active.	Have the system repaired by a qualified person.
The door stands still.	E51	Encoder/motor defective.	Have the system repaired by a qualified person.
The door stands still.	E53 E54	Anomaly in the travel distance. Solid obstruction in the movement area.	Remove firm obstacle in the traveling range of the door. Perform a software-reset. Have the system repaired by an expert.
The door stands still.	E61 E62 E63	Power supply is overloaded or voltage too low.	Get the power supply and connections checked by an expert.
The door stands still.	E64 E65	Drive/control system is overheated.	Wait for the automatic reset after the door/control system has cooled. Protect from direct sunlight.
The door stands still.	E66	Motor control defective.	Have the system repaired by an expert.
Door remains open or normal operation.	E73	Battery unit defective	Have the system repaired by an expert.
The door collides with people.	–	Safety device or setting inadequate.	Shut down the system. (see chapter 2.7).

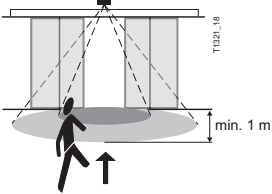
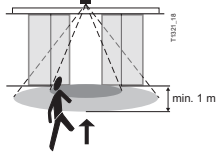
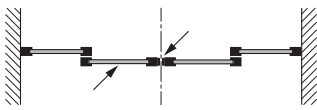
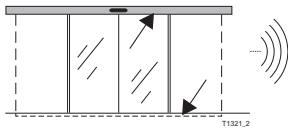
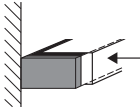
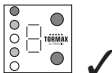
8.2 Check-list for Functional Checks

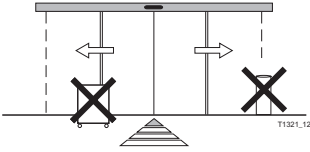
Item to be checked	Procedure	Result
Activating sensors		
	<ul style="list-style-type: none"> • Walk through the door directly from the front and from different directions at normal speed, starting both from the inside and outside . • Walk through the door directly from the front and from different directions at a slow speed like an infirm person, starting both from the inside and outside. Activation min. 1 m from main closing edge. 	<p>The door opens at the right time and with sufficient speed so that passage through the door is not hindered.</p> <p>The door opens and remains open until you are completely through the door.</p>
Safety sensors (can be combined with activating sensors)		
	<ul style="list-style-type: none"> • Walk through the door directly from the front and from different directions at a slow speed like an infirm person, starting both from the inside and outside. Activation min. 1 m from main closing edge. 	<p>The door opens and remains open until you are completely through the door.</p>
Moving leaves, side parts, fixed leaves		
	<ul style="list-style-type: none"> • Check the glass door fillings, door edges and rubber profiles for damage. 	<p>The door fillings have no sharp edges and splintered glass.</p> <p>The side parts and the door seals are in place and undamaged.</p>
Guide system and door guides		
	<ul style="list-style-type: none"> • Check the noises made while the door moves. 	<p>No unusual and noticeable movement noises can be heard in the drive, guide system or floor guides.</p>
Cladding		
	<ul style="list-style-type: none"> • Check whether the cladding is correctly slotted into place and secured. 	<p>The cladding is firmly slotted into place.</p>
Operating controls		
	<ul style="list-style-type: none"> • Check the function and marking of operating controls. 	<p>The operating controls are functioning correctly; the markings are visible and legible.</p>

Item to be Checked	Procedure	Result
System vicinity		
 <p>The diagram shows a top-down view of a door system. A horizontal bar is supported by a central pivot. Two door leaves are shown with arrows indicating their movement. A shaded triangular area around the pivot represents the clearance zone. Two 'X' marks are placed within this zone, indicating that objects like shelves or plant containers are not allowed there. A small code 'T1321,12' is visible in the bottom right of the diagram.</p>	<ul style="list-style-type: none"> • Check access to the door and the movement area of the door leaves. 	<p>Access to the door is free from objects and items likely to cause the user to trip. There are no objects such as shelves, plant containers and umbrella stands within a radius of 50 cm of the movement area.</p>
Power supply cable		
	<ul style="list-style-type: none"> • Check whether the power supply cable outside the drive is damaged. 	<p>If the power supply cable is damaged, it must be replaced by a technician.</p>



EC Declaration of Conformity

The manufacturer (installation company) of the complete door system declares

Manufacturer's address: _____

that the product (door system)

Type designation: _____

Serial number: _____

is in conformity with the directive 2006/42/EC (Machinery Directive)

is in conformity with regulations of the guidelines:

- 2014/35/EU (low tension)
- 2014/30/EU (electro-magnetic-compatibility)

and the following harmonised standards have been adhered to:

- EN 16005

Base document:

- Declaration of incorporation by TORMAX | LANDERT Group AG
- Risk evaluation for automatic sliding doors | T-1178

Person responsible for documents

Name/address: _____

Place, date: _____

Signatory

(CE authorized person): _____

Signature: _____



the passion to drive doors

TORMAX Swing Door Drives

TORMAX Sliding Door Drives

TORMAX Folding Door Drives

TORMAX Revolving Door Drives

Manufacturer

TORMAX
Unterweg 14
CH-8180 Bülach-Zürich
Phone +41 58 500 5000
Fax +41 58 500 5099
www.tormax.com
info@tormax.com

Installation company

(installation, repairs, maintenance)

TORMAX is a division and a registered trademark of LANDERT Group AG